

MODEL NO	SİYAH (BLACK)	F1 (N)	F2 (N)	F3 (N)	F4 (N)	Fi		BASKI VİDASI (SQUEEZE SCREW)	AÇI (ANGLE) ($\pm 5^\circ$)	AĞIRLIK (WEIGHT) (gr ± 2)
						(X1) VERİM (YIELD) (F1:Fi)	(X2) VERİM (YIELD) (F2:Fi)			
113-1	B 113-....	850	650	1000	800	7:1	3:1	M5X35	90°	155
113-2	B 113-....	1000	750	1200	1000	7:1	3:1	M6X40	90°	270
113-3	B 113-....	2300	1250	2500	1350	8:1	4:1	M8X50	90°	420
113-4	B 113-....	3500	1800	3650	2000	9:1	4:1	M10X70	90°	940
113-5	B 113-....	4500	2000	5000	2125	10:1	5:1	M12X80	90°	1840

F1 - F2 : BASKI KUVVETİ (EXERTING FORCE) , F3 - F4 : TUTMA KAPASİTESİ (HOLDING CAPACITY) , Fi : UYGULAMA KUVVETİ (APPLIED FORCE)

113

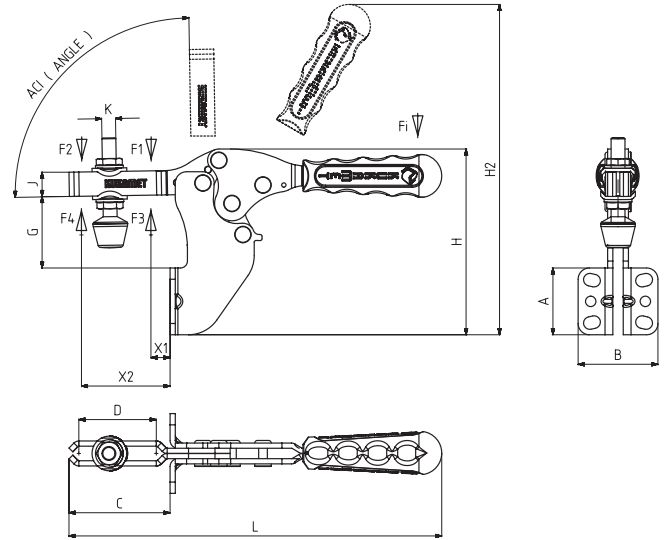
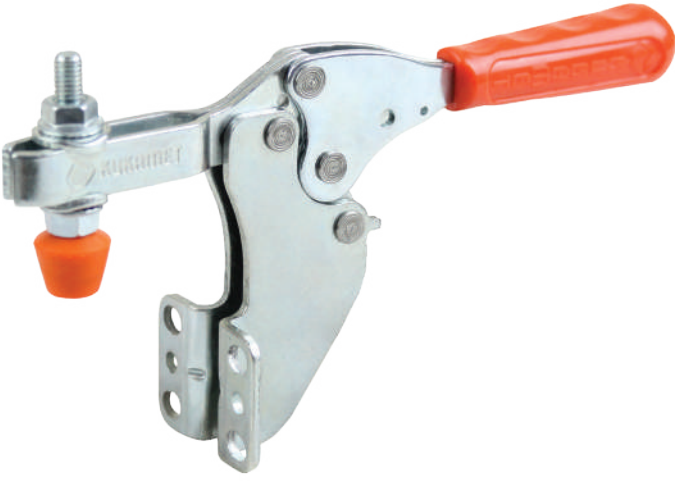

Ayak Tipi: Yan Tabanlı
Body Mounting Base: Side Ward

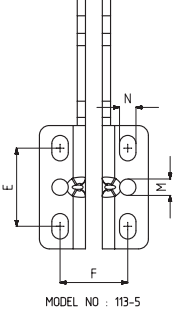
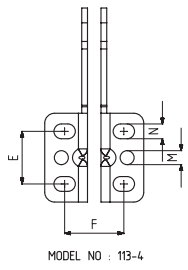
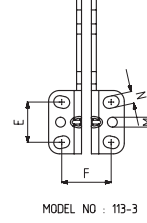
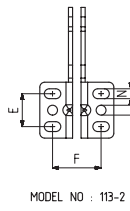
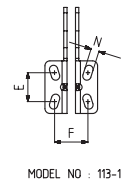

MODEL NO	A	B	C	D	E	F	G	H	H2	J	K	L	M	N	X1	X2
113-1	32	32	40	28	17,5	20	22,5	73	128	10	M5	148	-	5x9	12	30
113-2	34	45	60	47	20	29,5	34	90	149	14	M6	184	Ø 6	6x10	13	48
113-3	38,5	46	58	42	24,5	30	41	107	183	14	M 8	215	Ø 6	7x9,5	16	44
113-4	54	60	91	73	32	36	46,5	135	230	19	M10	296	Ø 8,5	9x13	18	74
113-5	75	66	117	92	47,5	42	54	177	291	25,5	M12	345	Ø 10	10x15,5	25	95