

MODEL NO	SİYAH (BLACK)	F1 (N)	F2 (N)	F3 (N)	F4 (N)	F5 (N)	F6 (N)	F7 (N)	F8 (N)	F _i		AÇI (ANGLE) (± 5°)	AĞIRLIK (WEIGHT) (gr ±%2)		
										(X1) VERİM (YIELD) (F1:F _i)	(C1) VERİM (YIELD) (F2:F _i)		C1	C2	C3
111-1-D	B 111 -	850	650	200	100	1000	800	200	125	7:1	3:1	90°	108	134	152
111-2-D	B 111 -	1000	750	300	220	1200	1000	350	250	7:1	3:1	90°	204	230	254
111-3-D	B 111 -	2300	1250	560	400	2500	1350	740	530	8:1	4:1	90°	300	328	362
111-4-D	B 111 -	3500	1800	900	700	3650	2000	1035	800	9:1	4:1	90°	720	782	847
111-5-D	B 111 -	4500	2000	1250	1000	5000	2125	1350	1080	10:1	5:1	90°	1378	1480	1580

F1 - F2 - F3 - F4 : BASKI KUVVETİ (EXERTING FORCE) , F5 - F6 - F7 - F8 : TUTMA KAPASİTESİ (HOLDING CAPACITY) , F_i : UYGULAMA KUVVETİ (APPLIED FORCE)

111-D

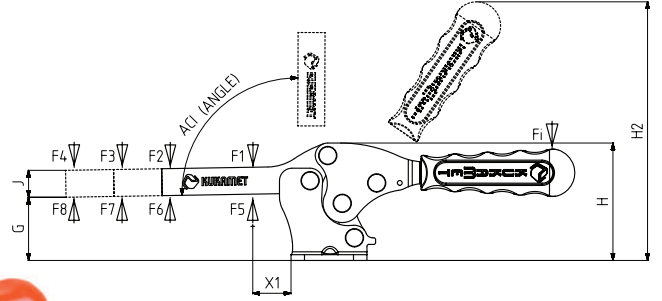

*911-951-G (sayfa 128-131)
 Bkz Aksesuar Sayfası
 *911-951 -G (page 128-131)
 Please See Accessories Page

Ayak Tipi: Çatay Tabanlı
 Body Mounting Base: Horizontal



111-D-L
 Sayfa/Page: 12



211-D
 Sayfa/Page: 18



211
 Sayfa/Page: 17

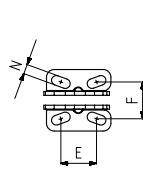

MODEL NO : 111-1-D

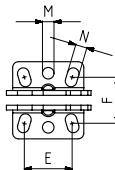

MODEL NO : 111-2-D

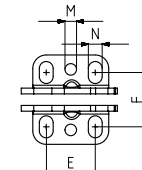

MODEL NO : 111-3-D

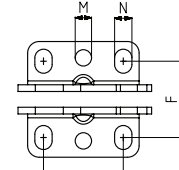

MODEL NO : 111-4-D

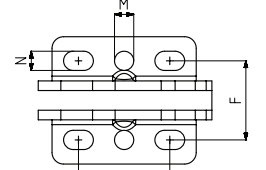

MODEL NO : 111-5-D

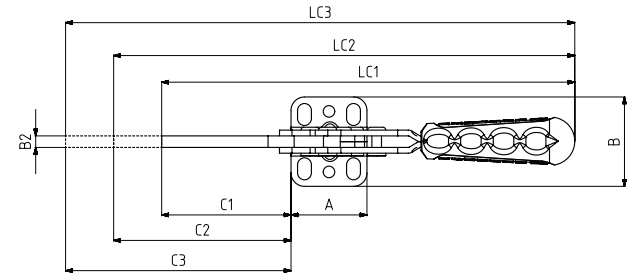

MODEL NO	A	B	B2	C1	C2	C3	E	F	G	H	H2	J	LC1	LC2	LC3	M	N	X1
111-1-D	33,5	32	5	43	93	143	18,5	19	21	40	95	10	148	198	248		5 x 10	15
111-2-D	37	40	5	66	116	166	25	24	28	51	110	14	184	234	284	Ø 6	6 x 10	19
111-3-D	39,5	46,5	6	68	118	168	25,5	28,5	34	61	136	14	215	265	315	Ø 6	7 x 11,5	25
111-4-D	58	60	8	100	150	200	41,5	39,5	45	82	175	19	296	346	396	Ø 8,5	9 x 12,5	27
111-5-D	75	66	10	129	179	229	47,5	42	55	104	218	25,5	345	395	445	Ø 10	10 x 15,5	37