

831



Ayak Tipi: Yatay Tabanlı
Body Mounting Base: Horizontal

Ürün özellikleri ;
Ağır iş uygulamalarında kullanıma uygun mukavemetli ürünlerdir.
Clamp çenesi sıcak dövme çelikten yapılmıştır ve civata dişleri ovalamadır.
Diğer parçaları çelik malzemeden üretilmiş ve korozyon direnci için galvaniz kaplama yapılmıştır.

Product Features;
The products are strong and suited for heavy duty applications.
The clamping jaw is made of hot forged steel.
The remaining parts are made of galvanized steel for corrosion resistance.



822

Sayfa/Page: 91



541-L

Sayfa/Page: 65

MODEL NO	F1 (N)	AĞIRLIK (WEIGHT) (gr ±%2)
831-2	8000	1610
831-3	8000	2300

F1 : BASKI KUVVETİ (EXERTING FORCE)

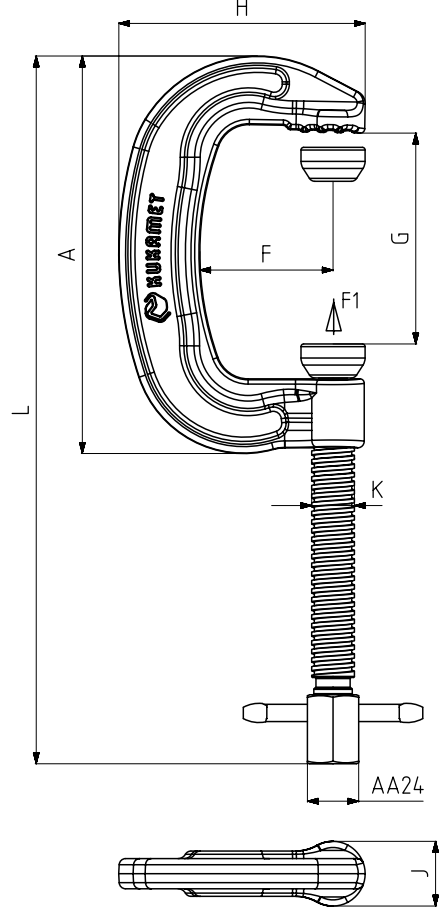

MODEL NO	A	F	G Min.	G Max.	H	J	K	L Min.	L Max.
831-2	184	62	0	90	115	30	TR20	235	325
831-3	257	73,6	0	140	139	30	TR20	300	440

