

MODEL NO	SİYAH (BLACK)	F1 (N)	F2 (N)	F3 (N)	F4 (N)	F5 (N)	F6 (N)	F7 (N)	F8 (N)	Fi		AÇI (ANGLE) (± 5°)		AĞIRLIK (WEIGHT) (gr)
										(X1) VERİM (YIELD) (F1:Fi)	(C1) VERİM (YIELD) (F2:Fi)	POS1	POS2	
213-1-D	B 213 - ....	750	500	250	175	1000	680	340	250	12:1	8:1	135°	105°	150
213-2-D	B 213 - ....	1200	700	350	250	1400	925	510	370	12:1	7,5:1	135°	105°	240
213-3-D	B 213 - ....	2000	1400	700	500	2500	1560	910	680	11:1	8:1	105°		430
213-4-D	B 213 - ....	3000	2000	1100	850	3300	2200	1350	1080	11,5:1	8:1	135°	105°	930
213-5-D	B 213 - ....	4500	2500	1300	1000	5000	3000	1445	1190	12:1	7:1	135°	105°	1640

F1 - F2 - F3 - F4 : BASKI KUVVETİ ( EXERTING FORCE ) , F5 - F6 - F7 - F8 : TUTMA KAPASİTESİ ( HOLDING CAPACITY ) , Fi : UYGULAMA KUVVETİ ( APPLIED FORCE )

**213-D**
**Ayak Tipi: Yan Tabanlı**  
 Body Mounting Base: Side Ward

\*911-951  
 Bkz. Aksesuar Sayfası  
 \*911-951  
 Please See Accessories Page

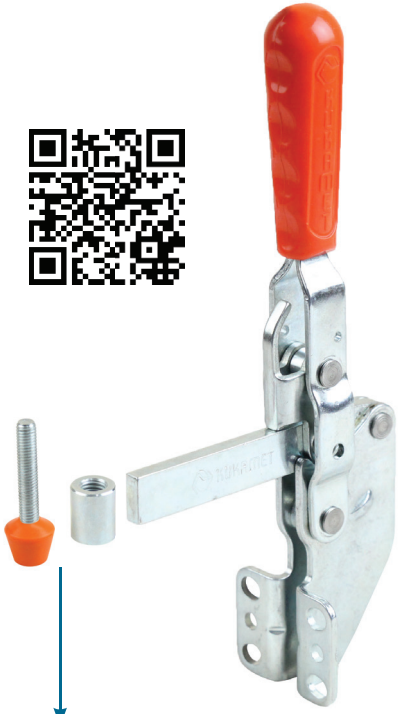
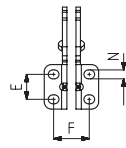
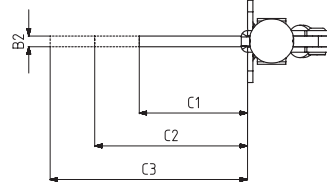
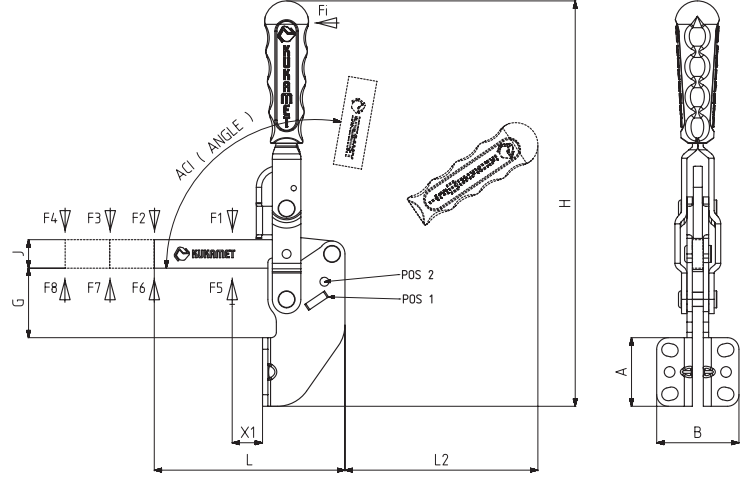

MODEL NO : 213-1-D

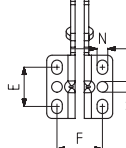

MODEL NO : 213-2-D

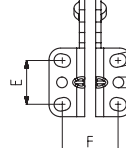

MODEL NO : 213-3-D

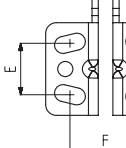

MODEL NO : 213-4-D

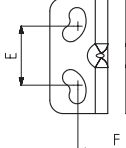

MODEL NO : 213-5-D



MODEL NO	A	B	B2	C1	C2	C3	D	E	F	G	H	J	L	L2	M	N	X1
213-1-D	25	30,5	5	38	88	138		14	19-21	22,5	150	10	70	75		5 x 6	12
213-2-D	35,5	37	5	58	108	158		20-24	25,5	25,5	175	13	94	85	Ø 6	6 x 8	15
213-3-D	38,5	46	6	61	111	161		24-25	29-33	39	228	16	107	110	Ø 6	7 x 9	19
213-4-D	52	67	8	91	141	191		27-30,5	32-47,5	48	292	20	152	160	Ø 8,5	9,5 x 17,5	24
213-5-D	65	75,5	10	118,5	168,5	218,5		24,5-45	44,5-52	59	328	25	195	165		9 x 19,5	30